

1/25 (row1 col1)

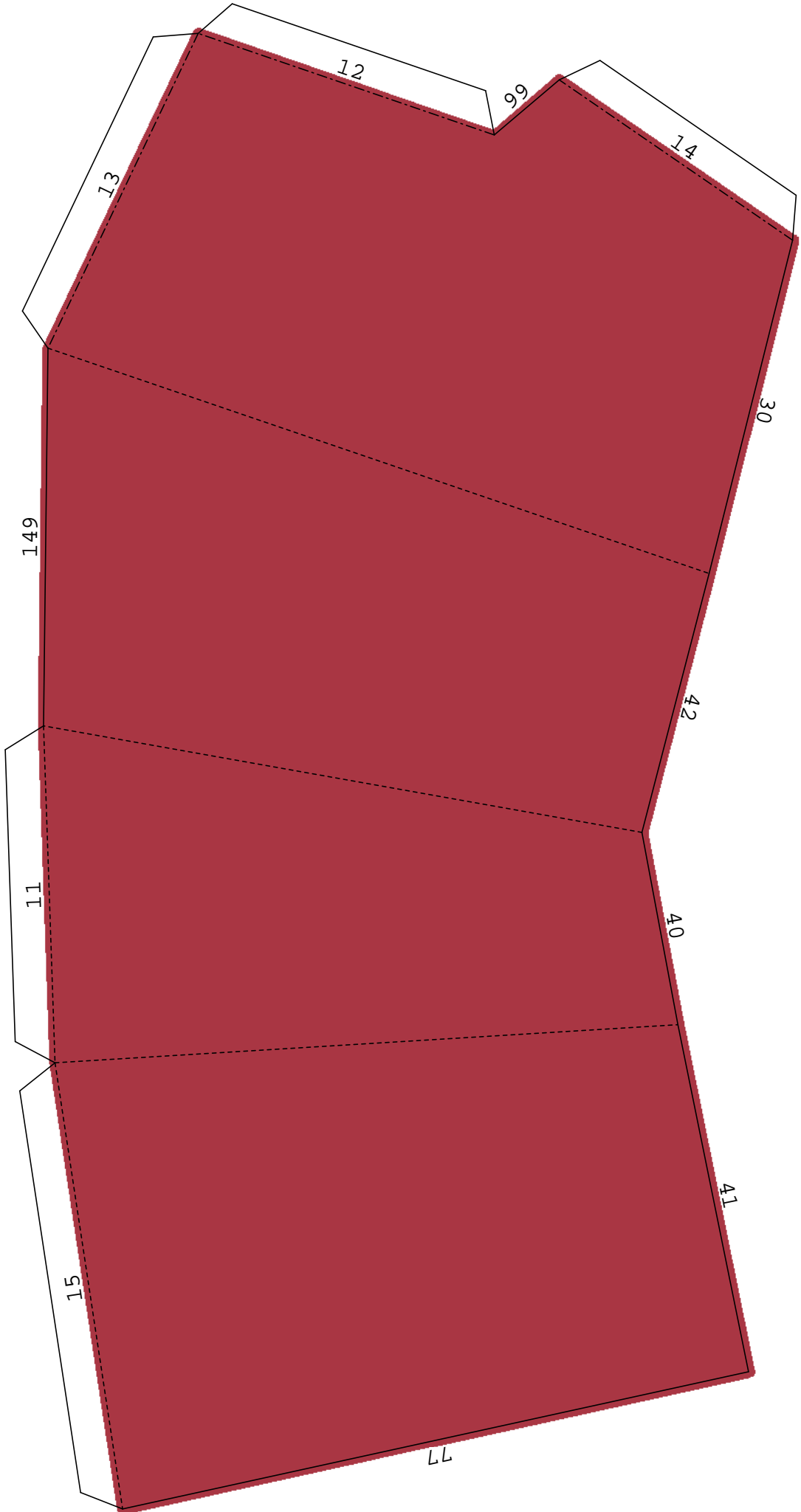

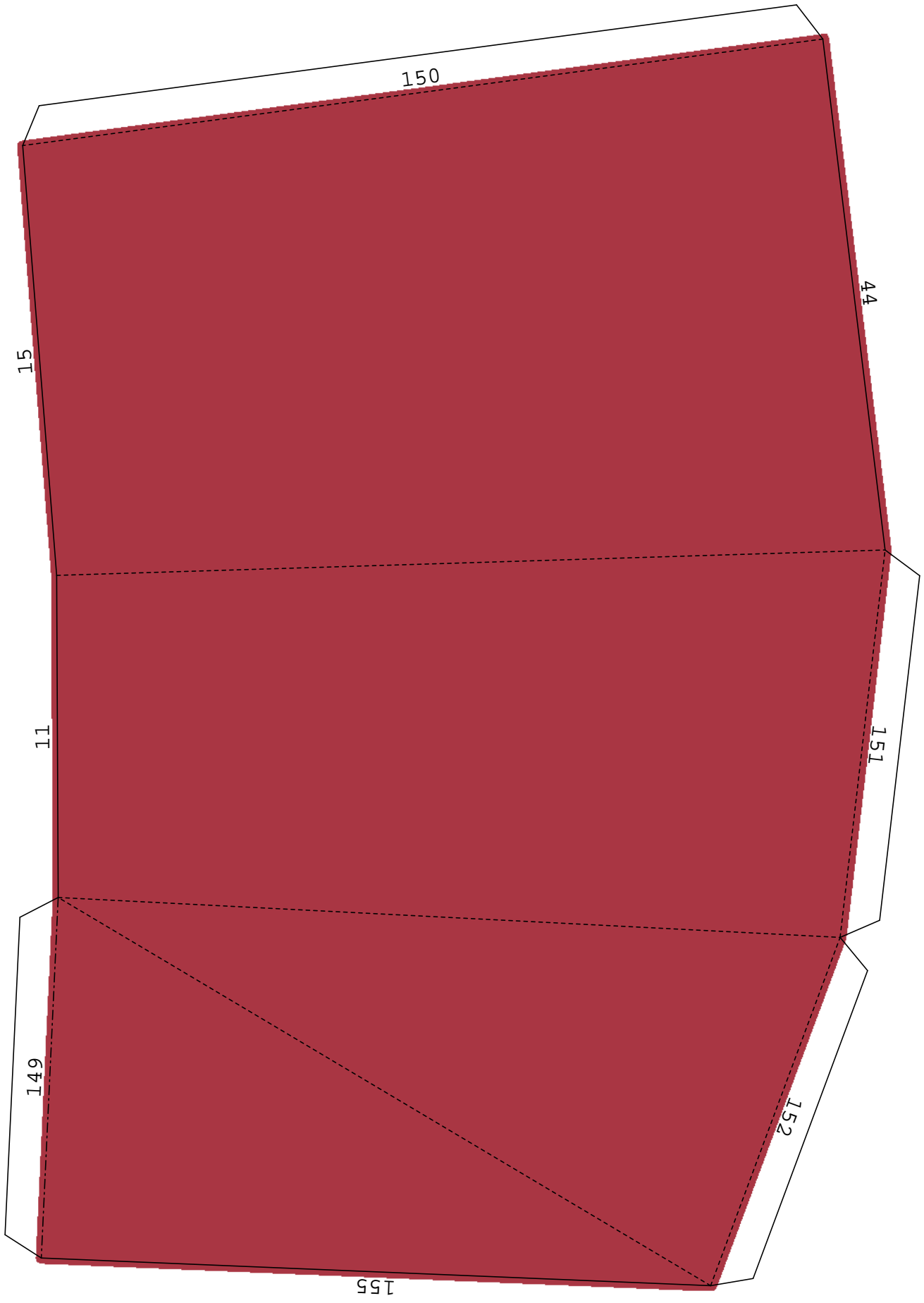

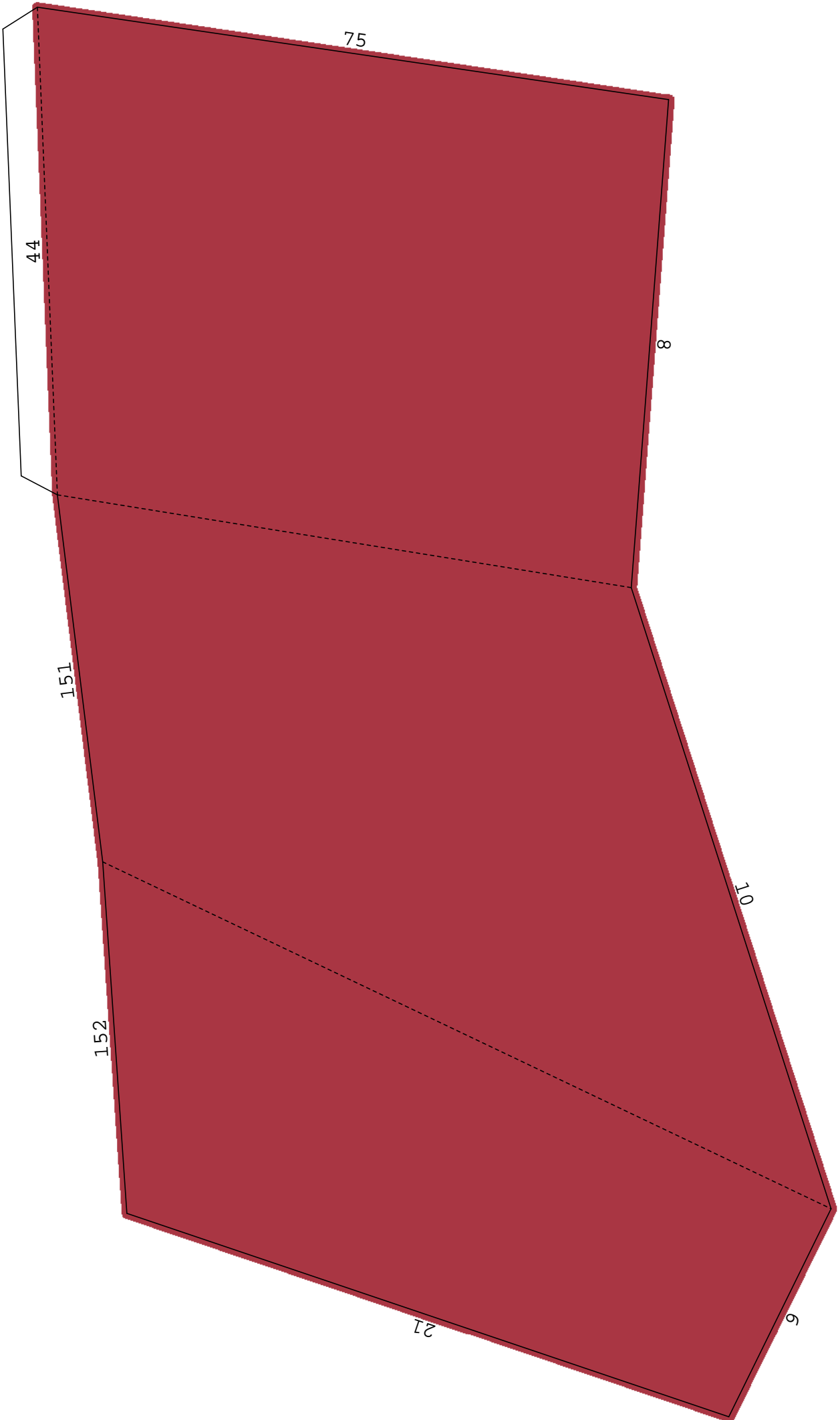

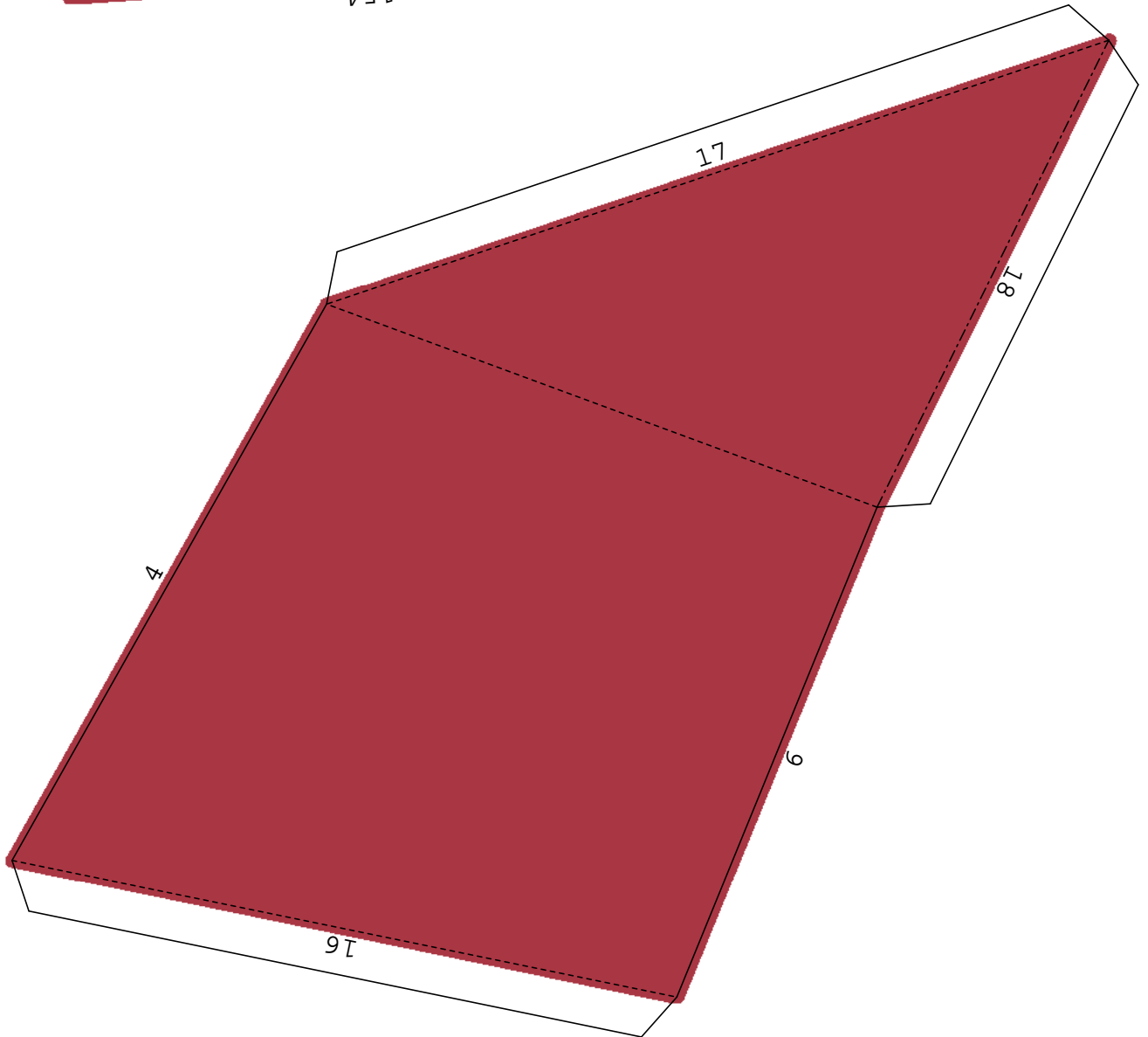
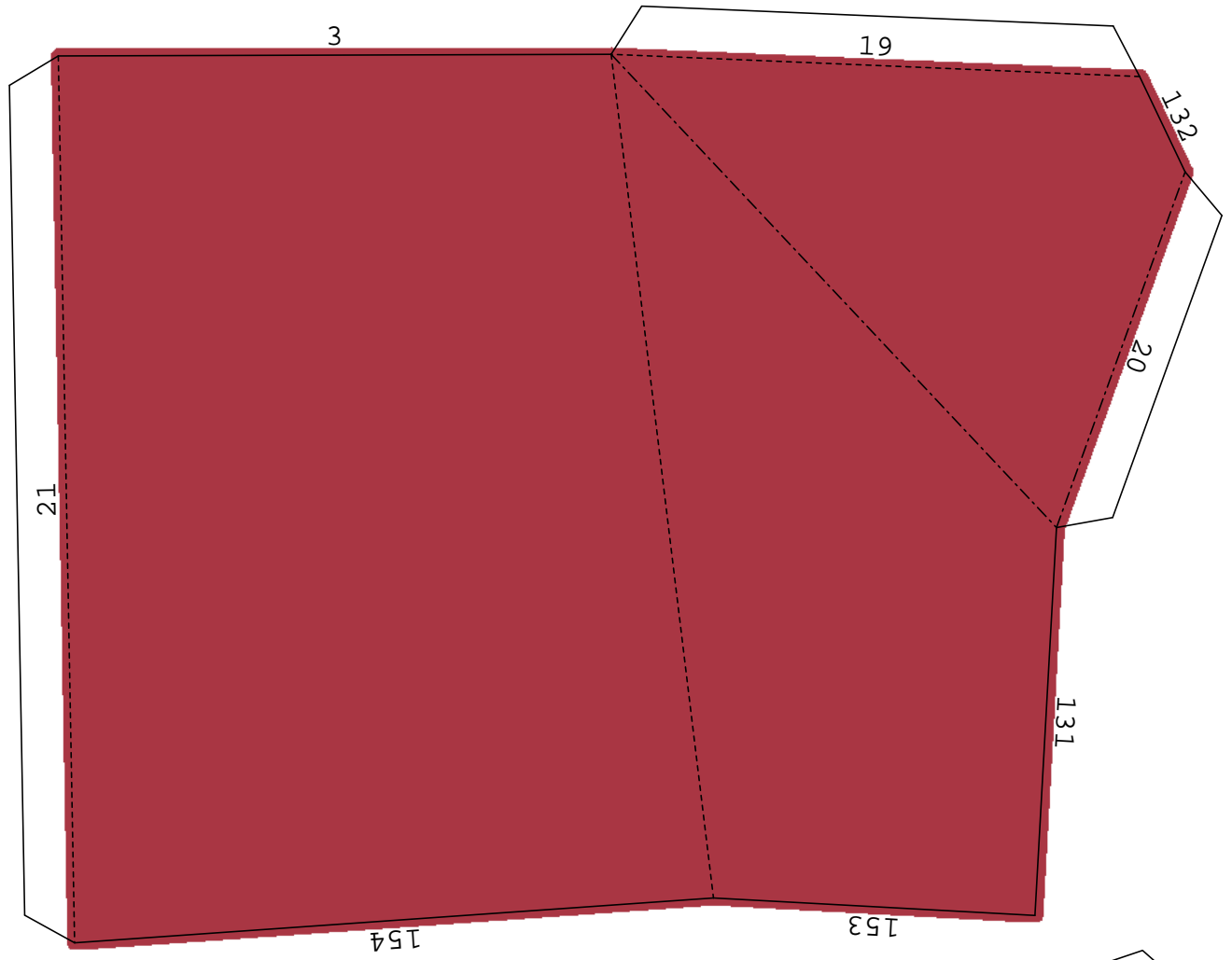

5/25 (row1 col5)

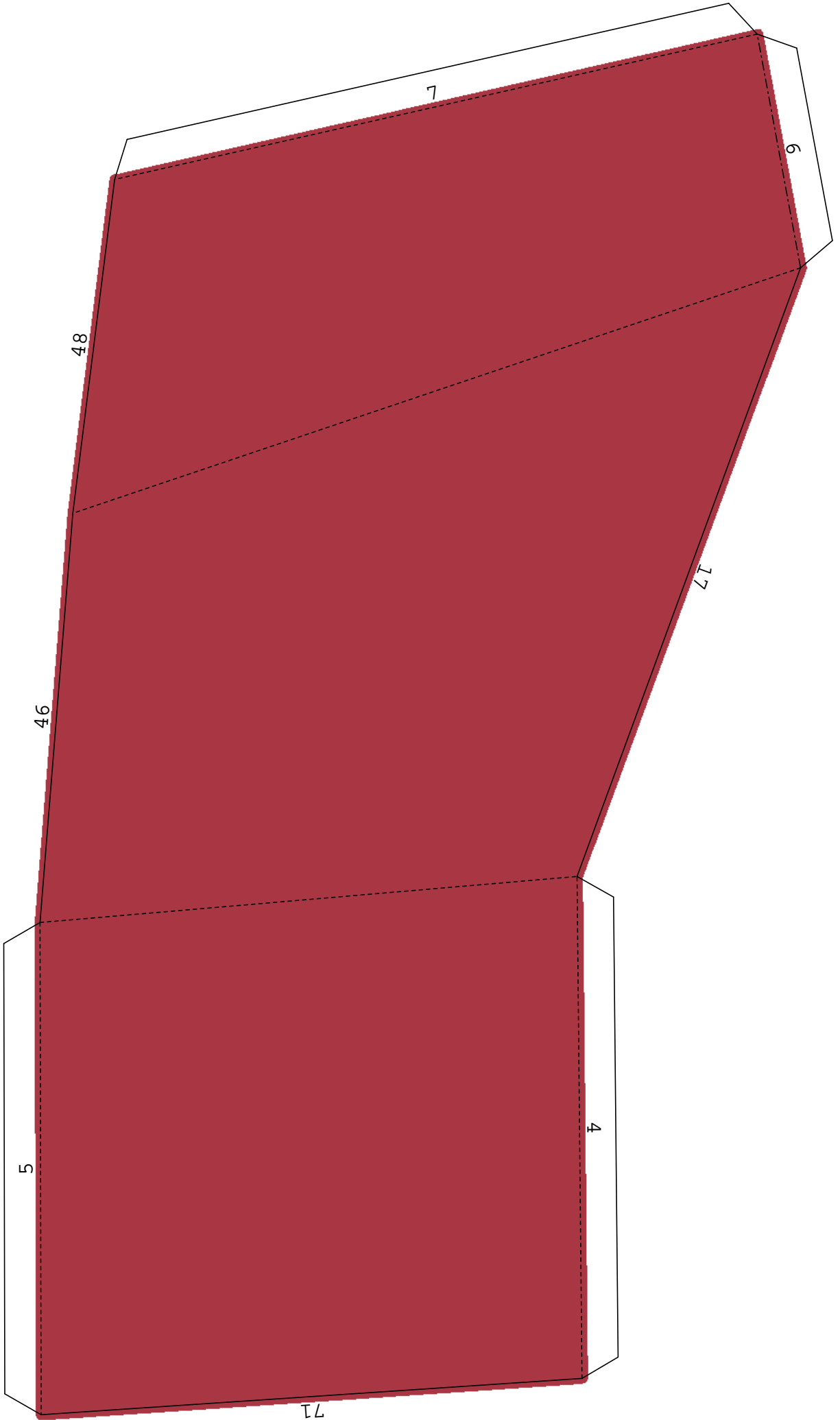

6/25 (row2 col1)

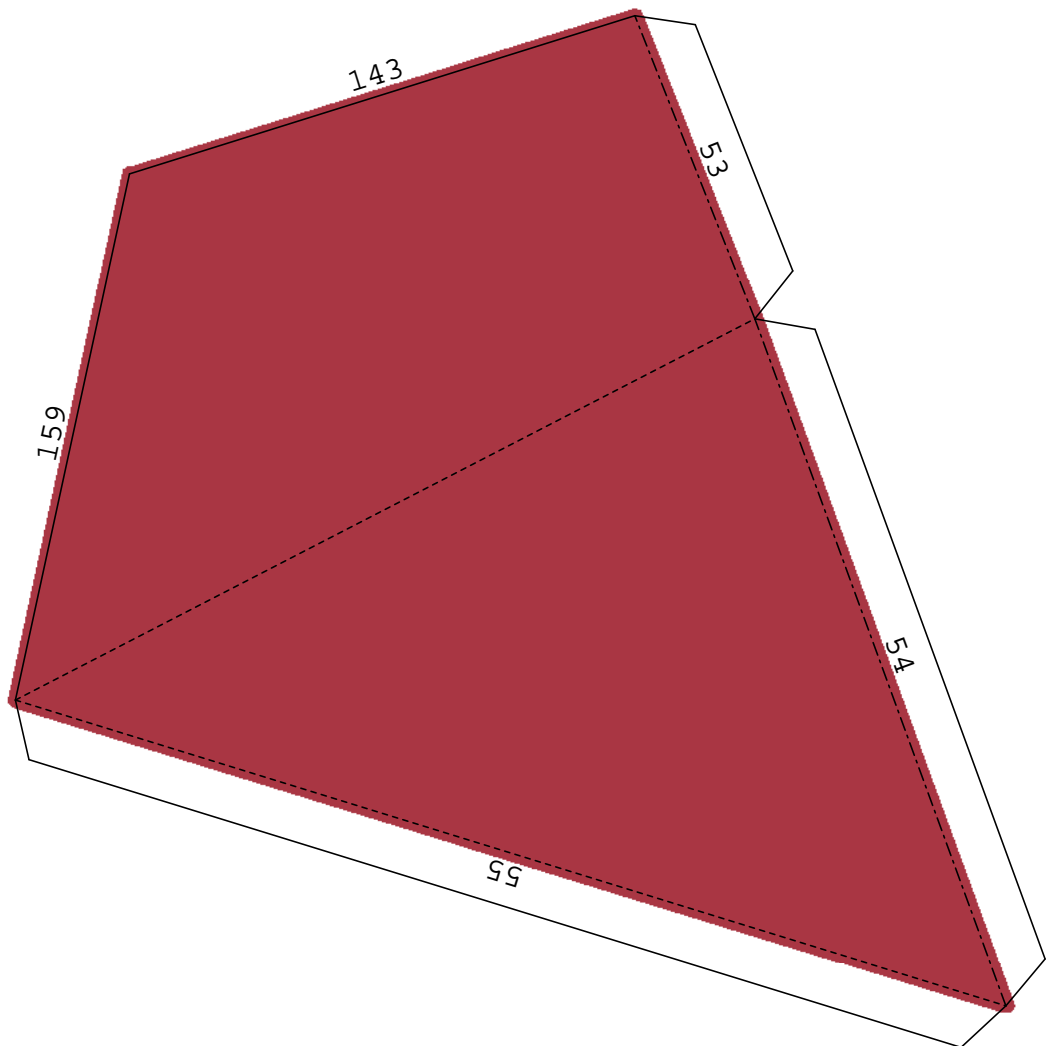
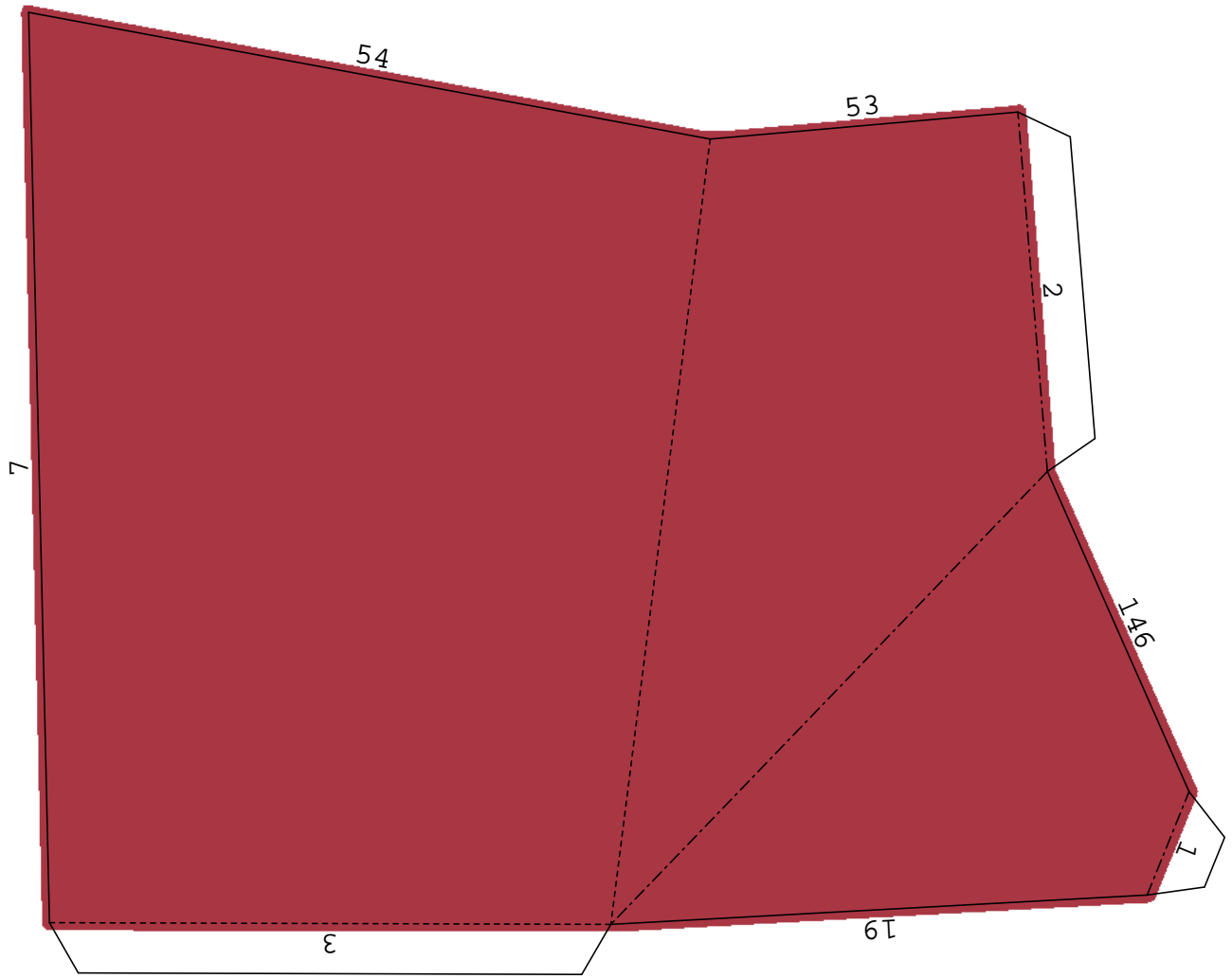

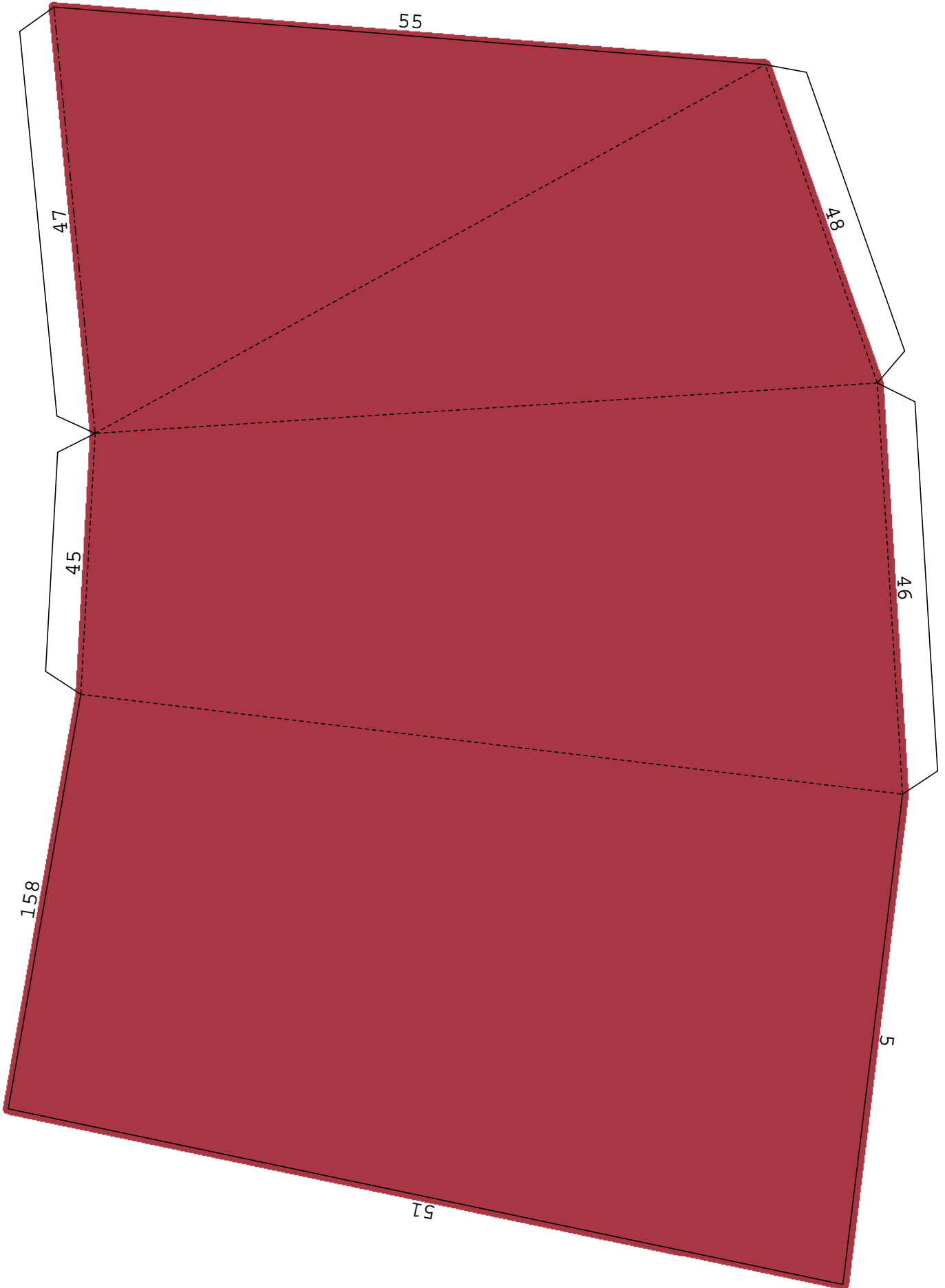



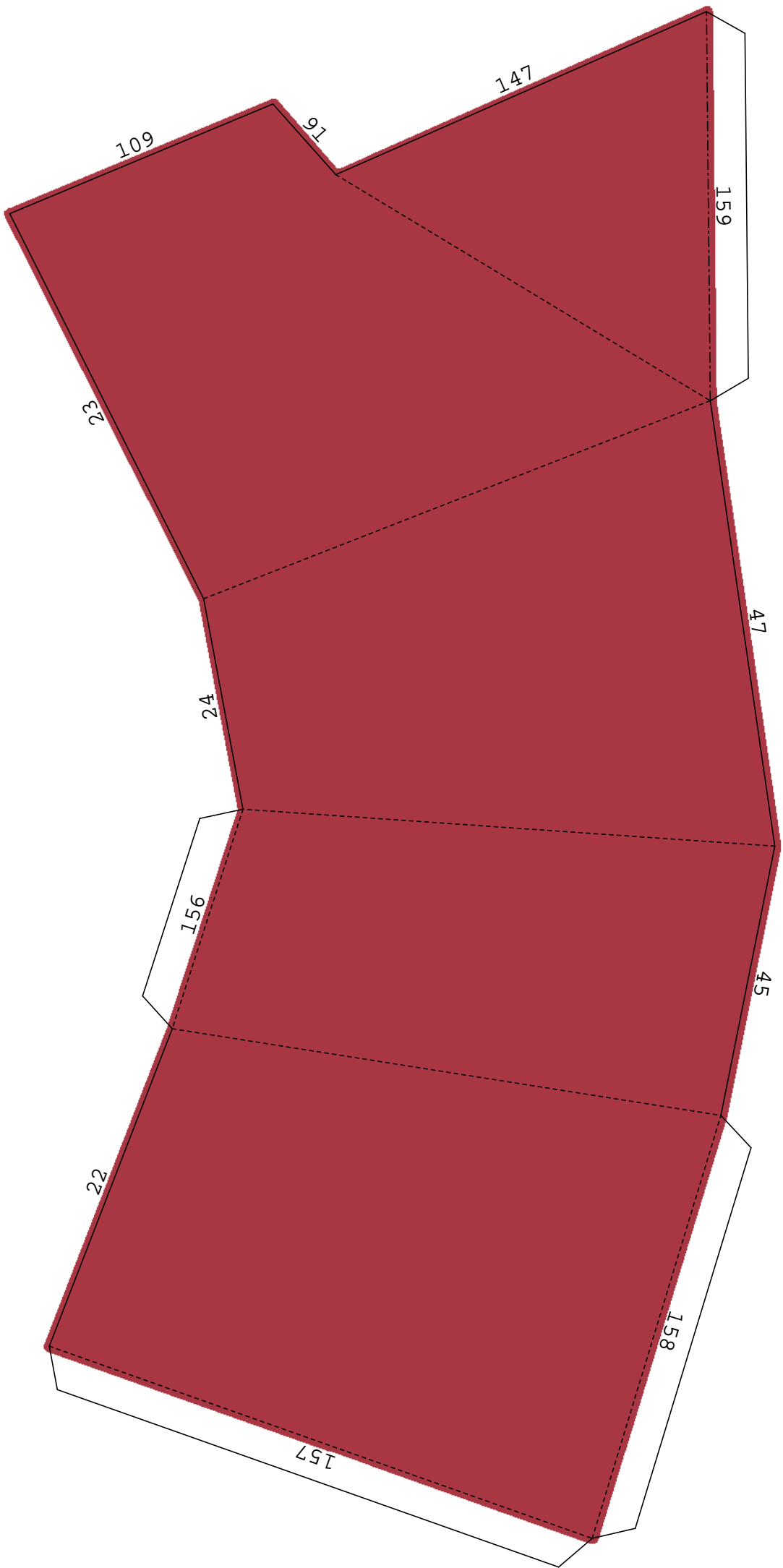

9/25 (row2 col4)

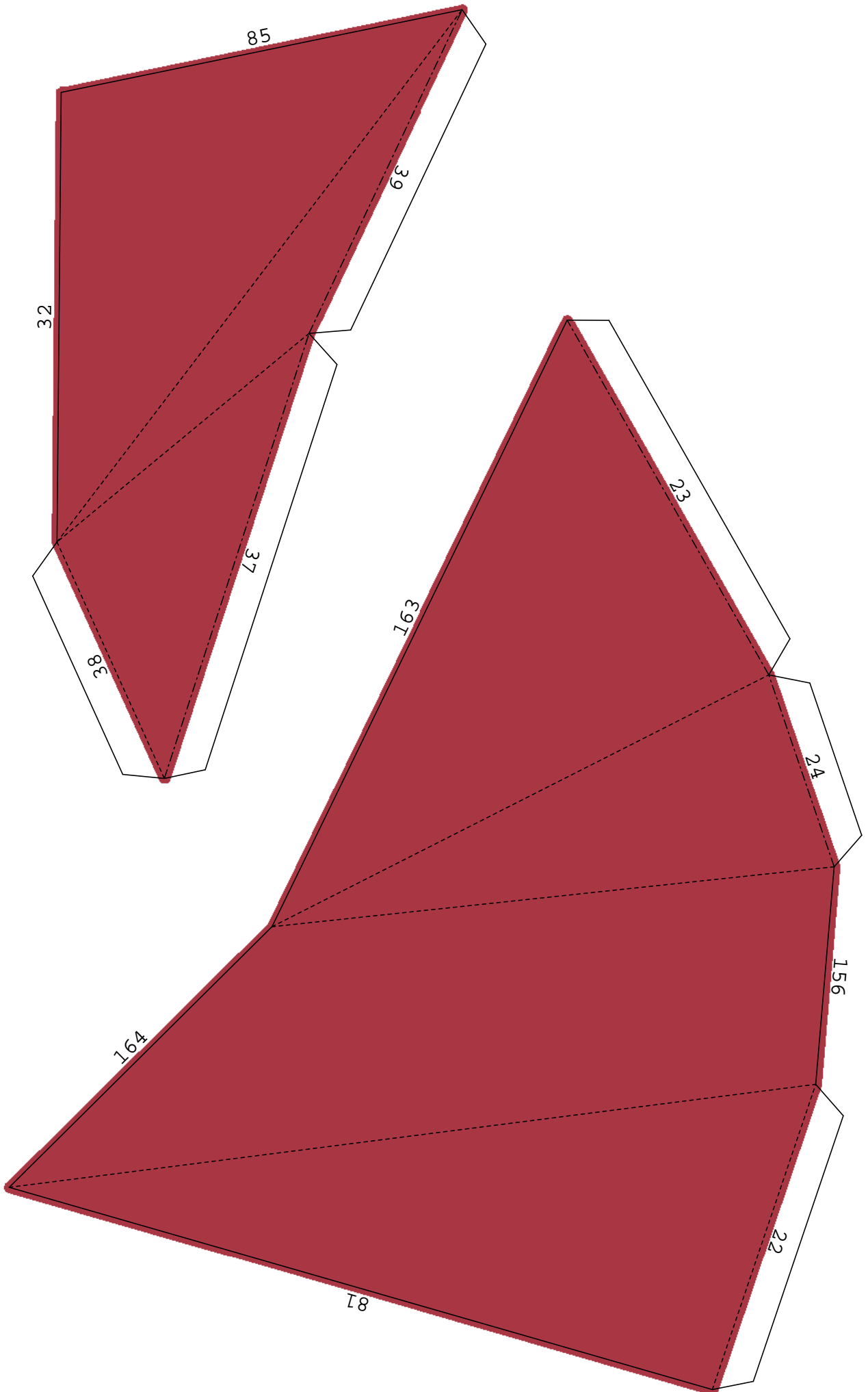

10/25 (row2 col5)

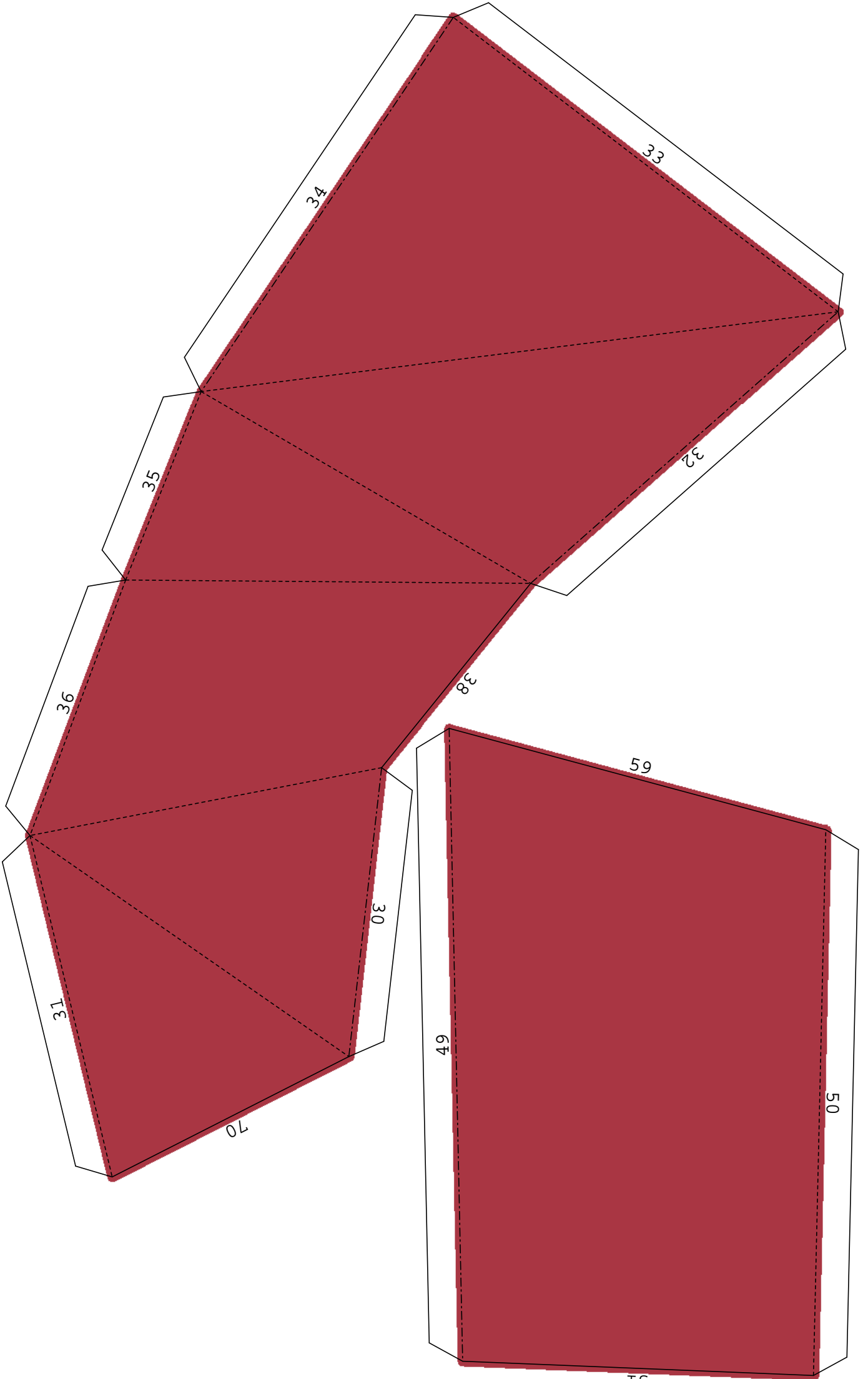

11/25 (row3 col1)

31

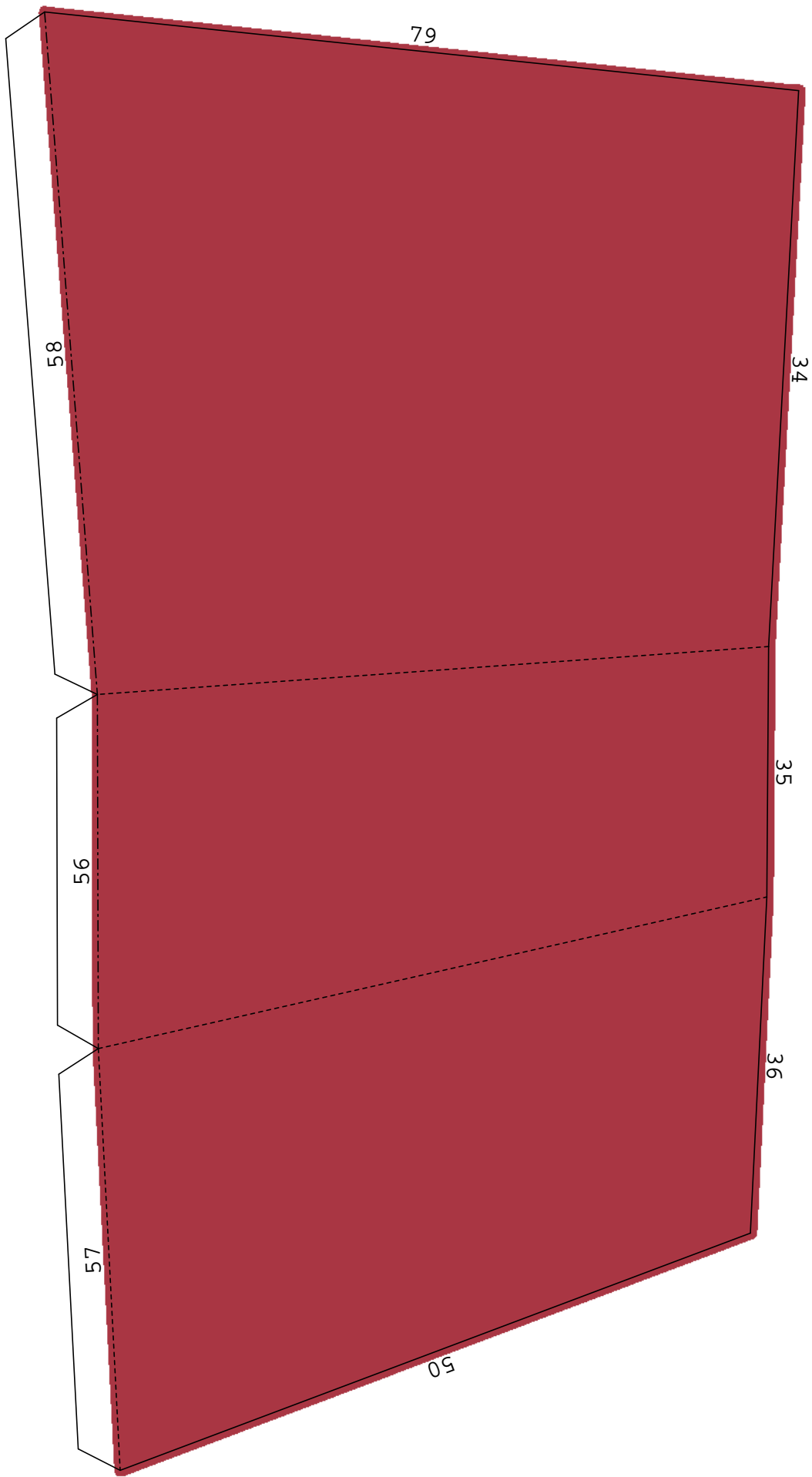

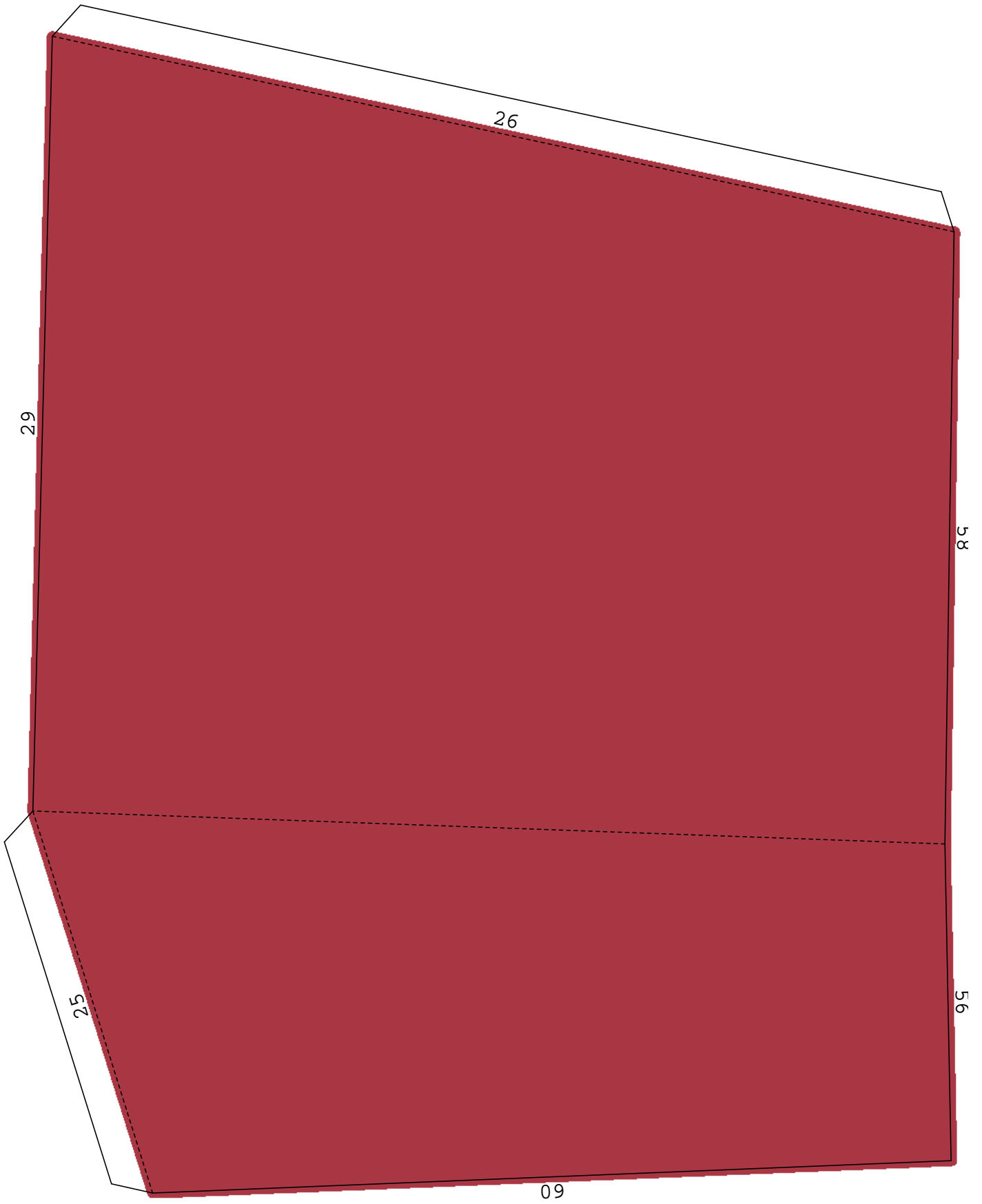

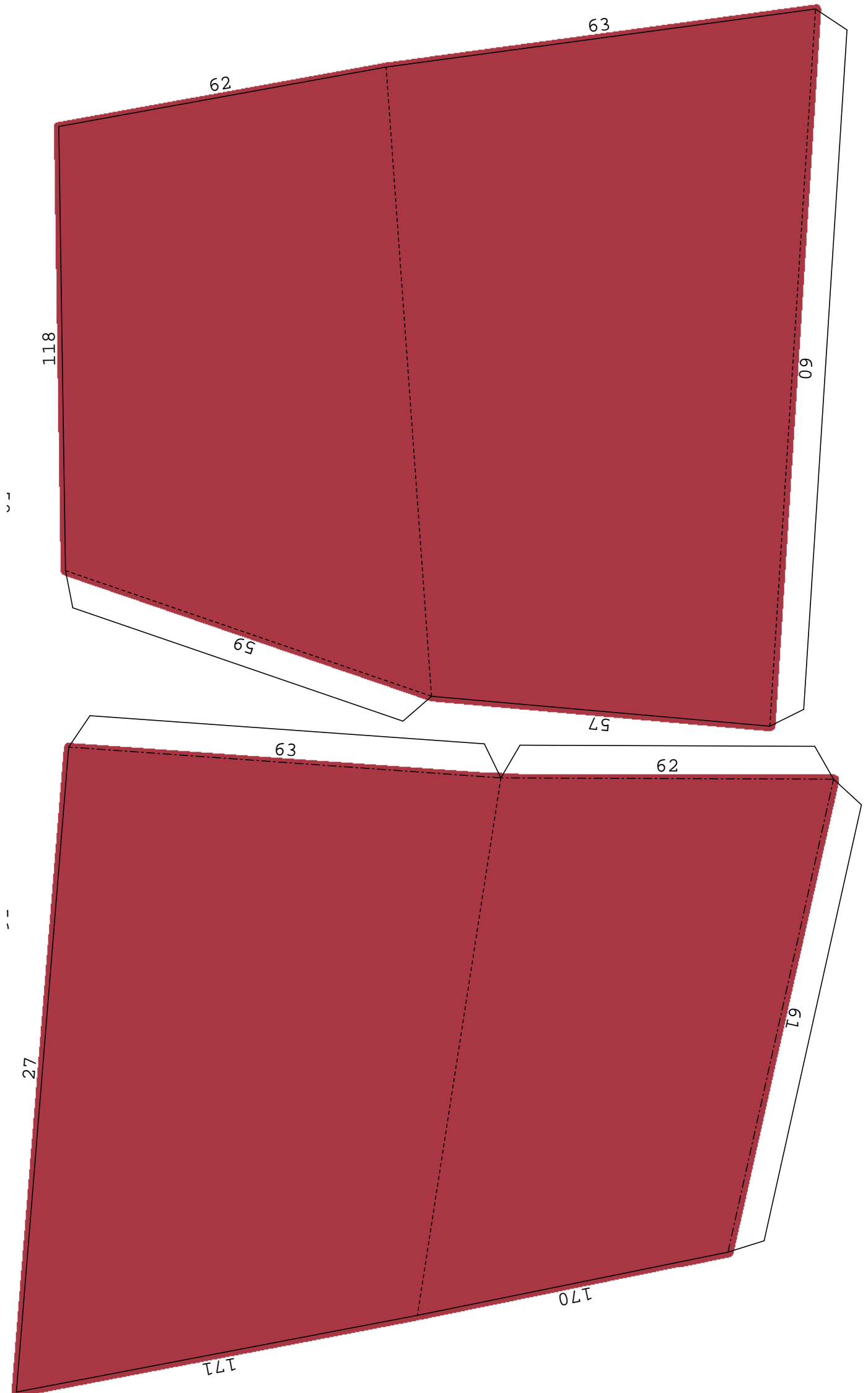

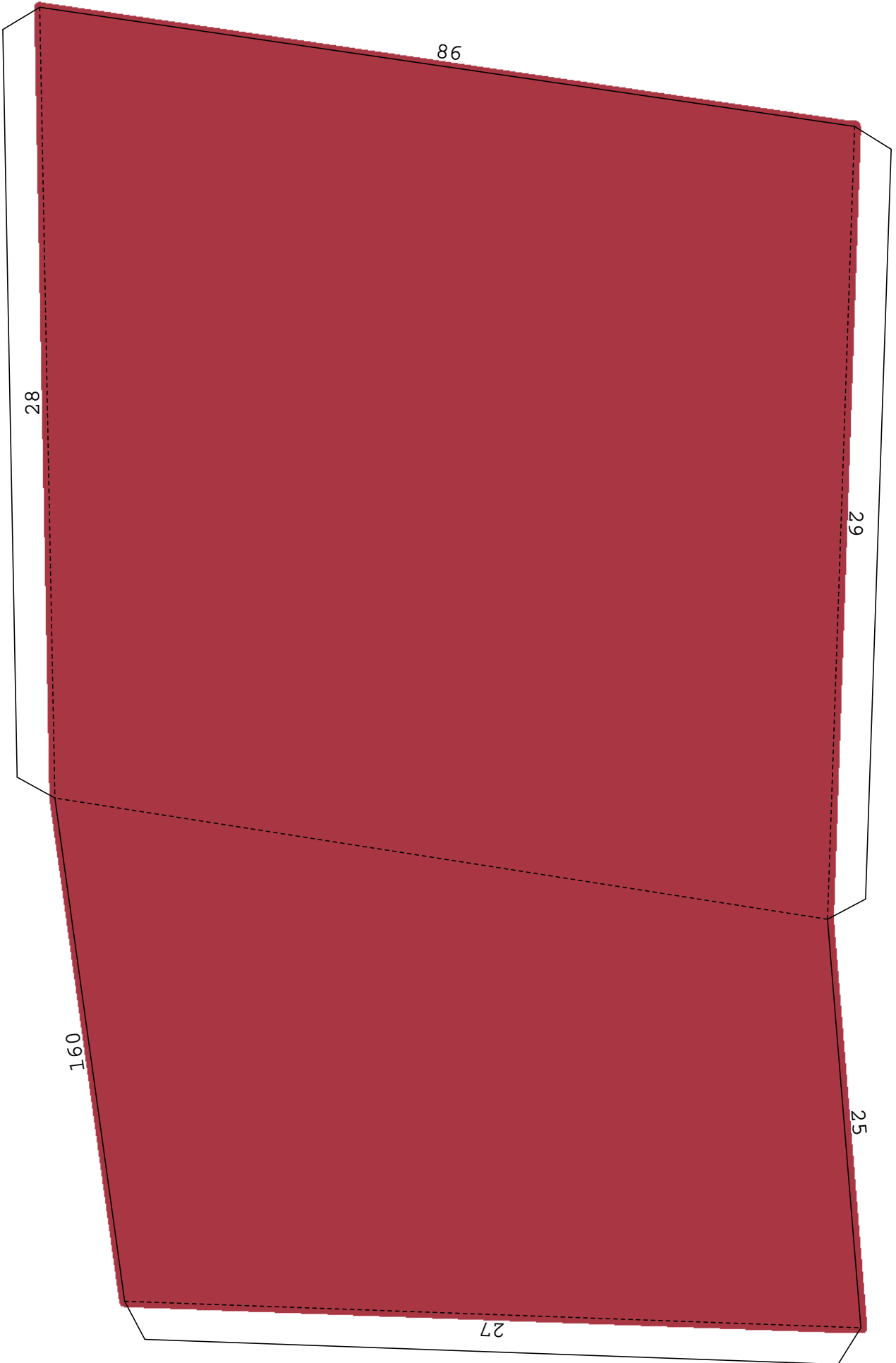

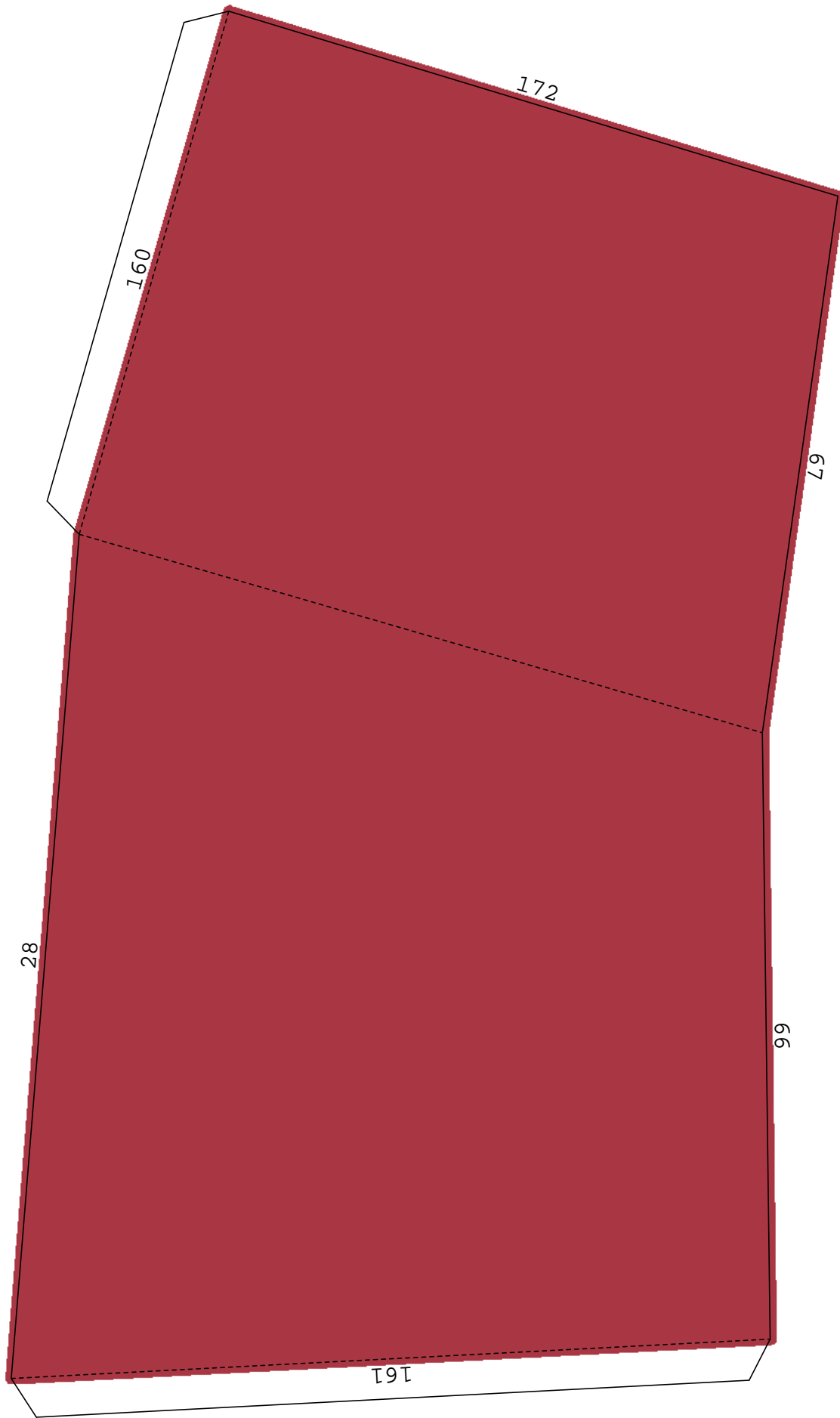



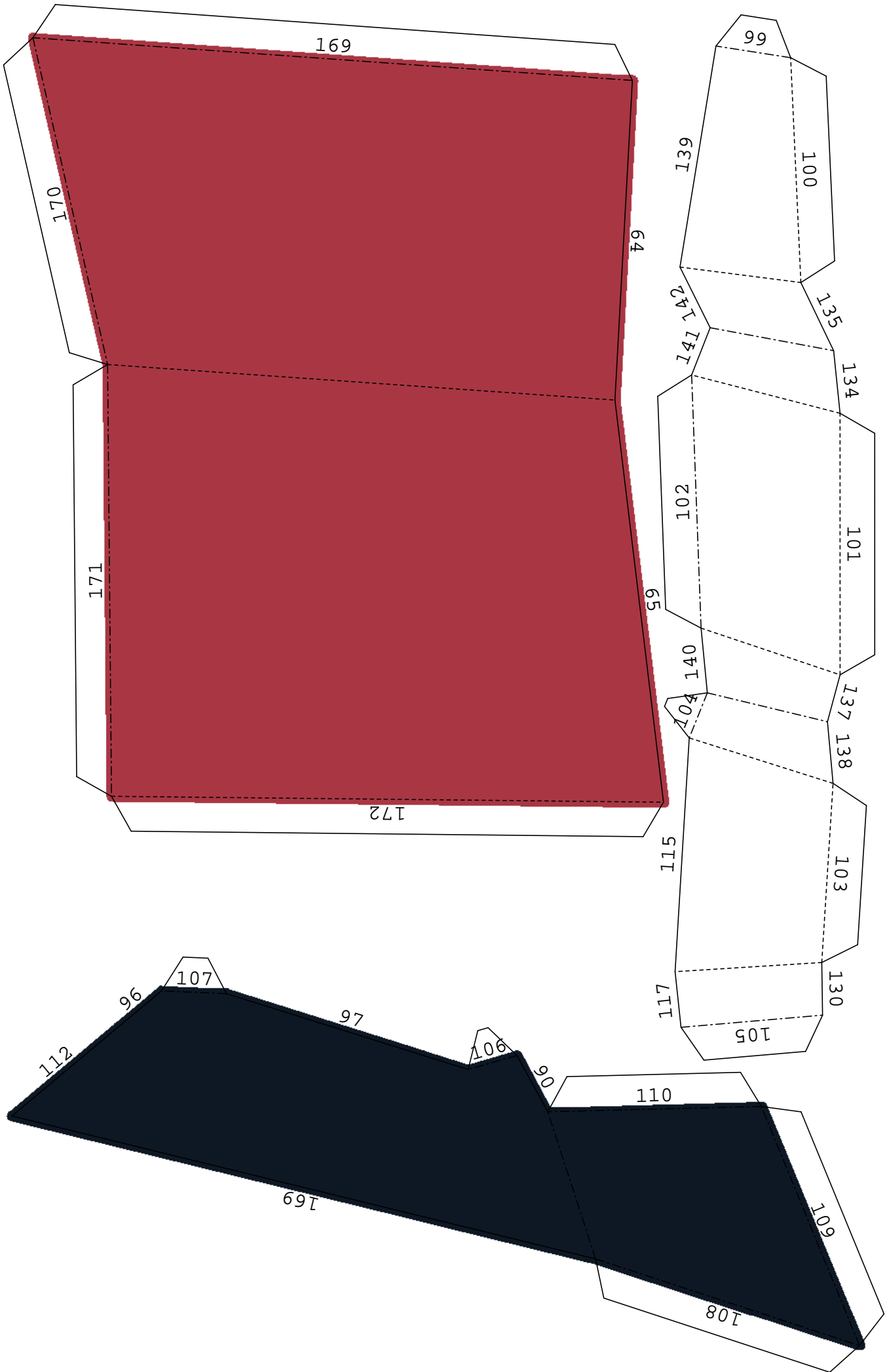

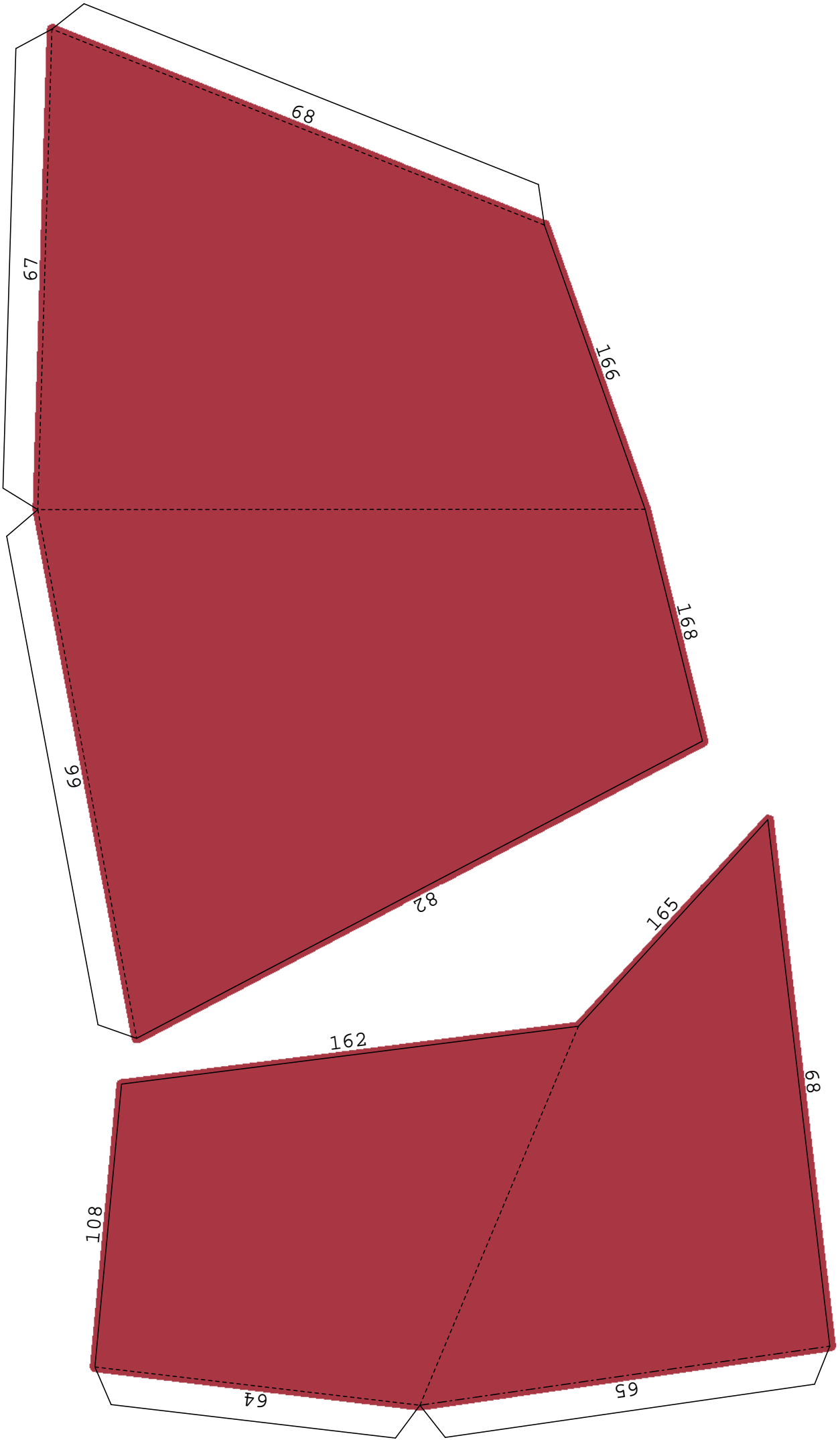

18/25 (row4 col3)

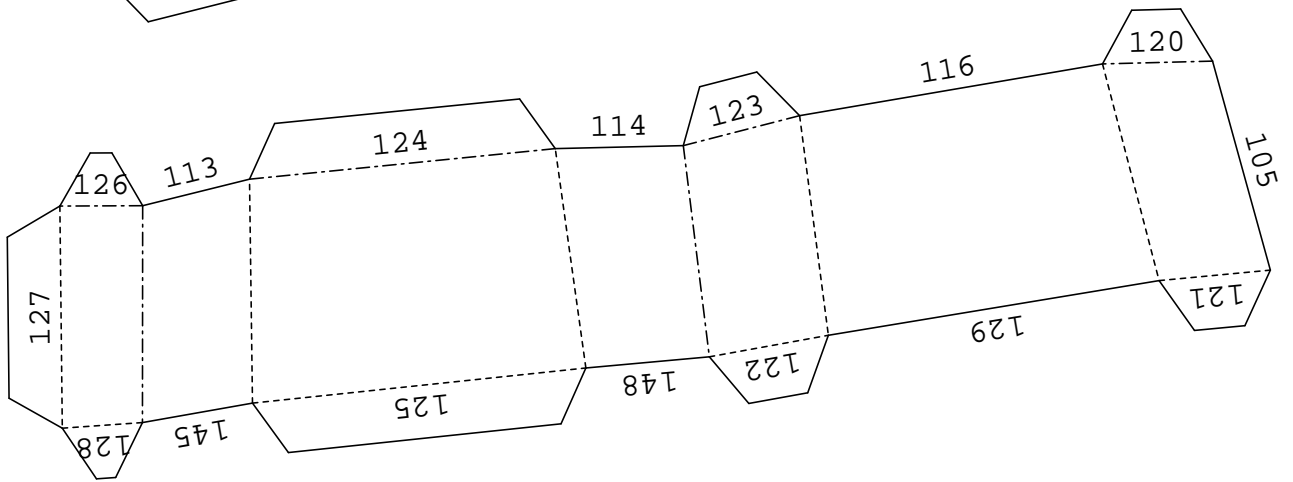
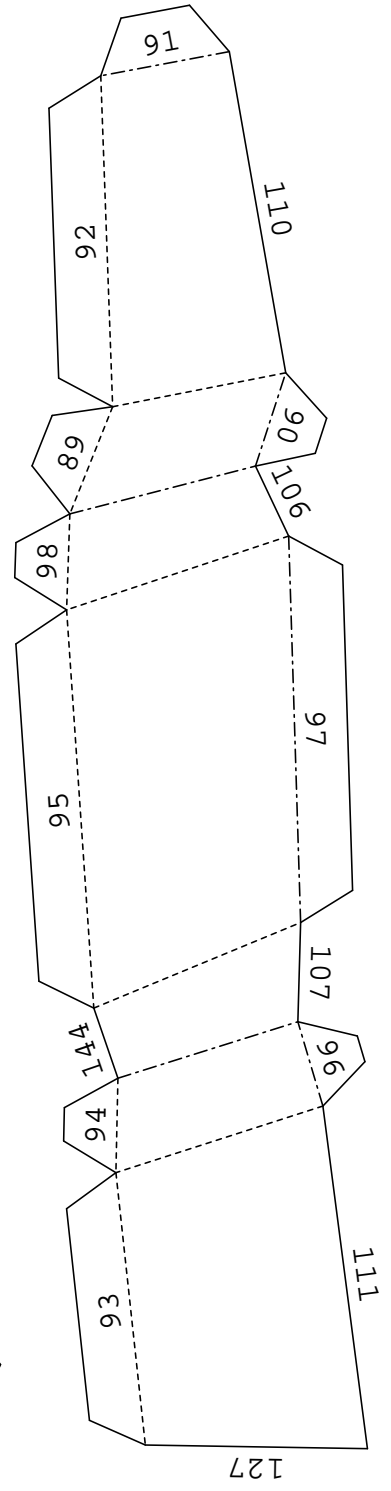
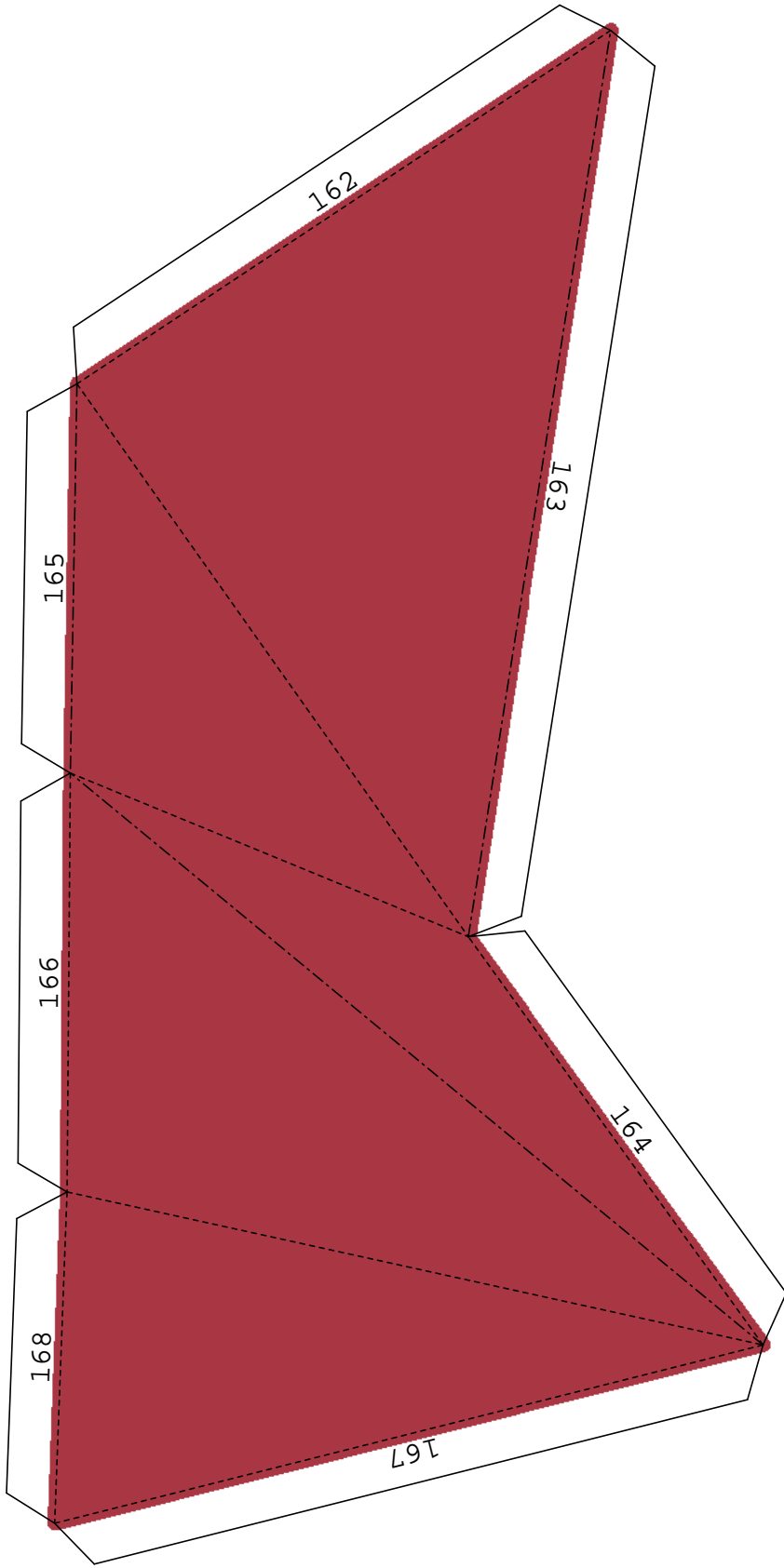

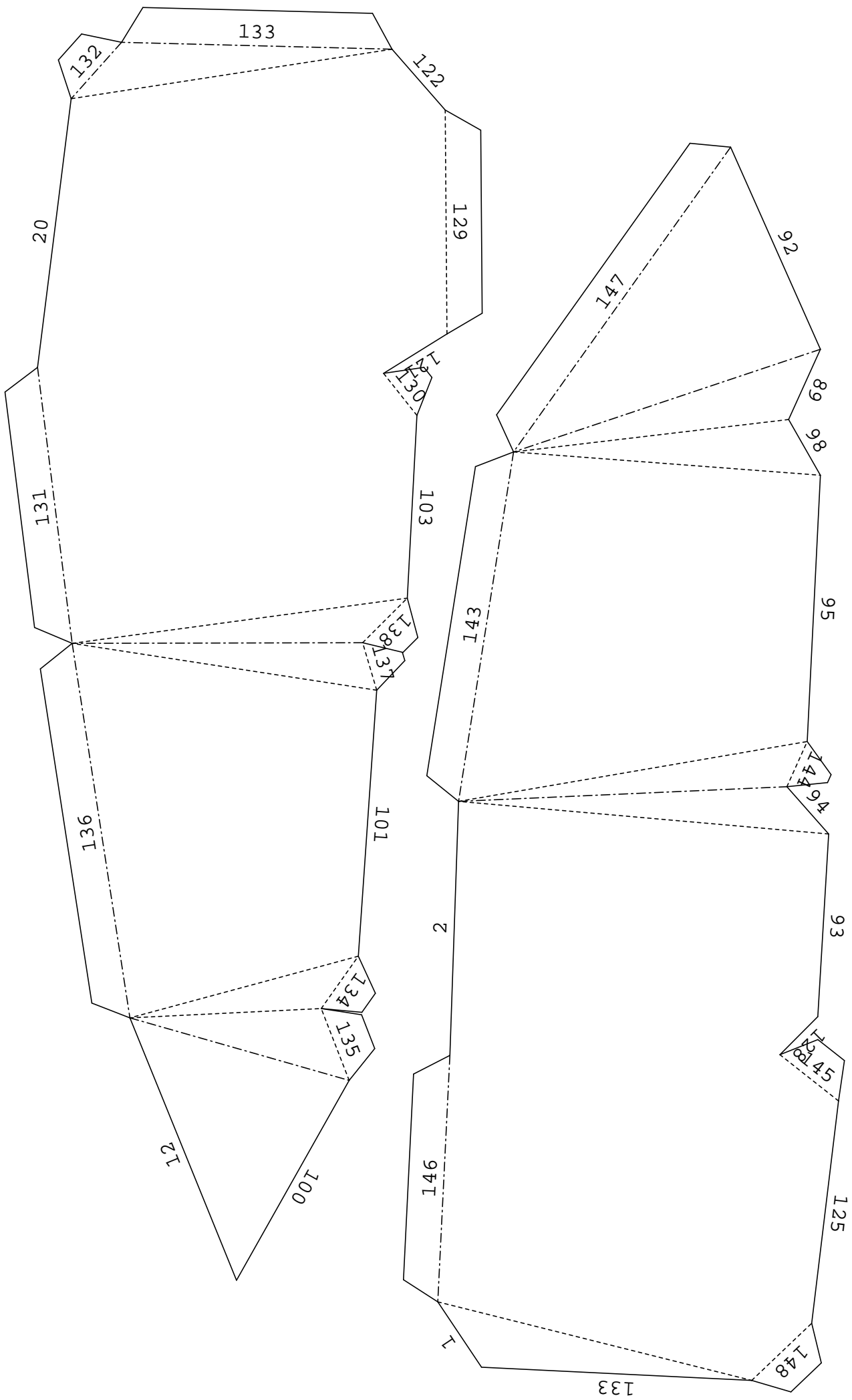

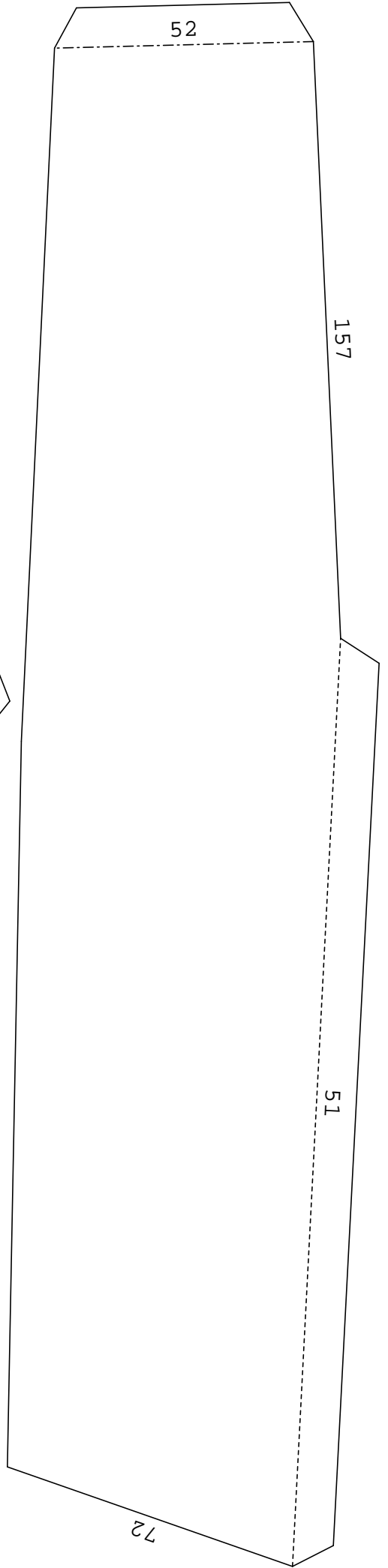
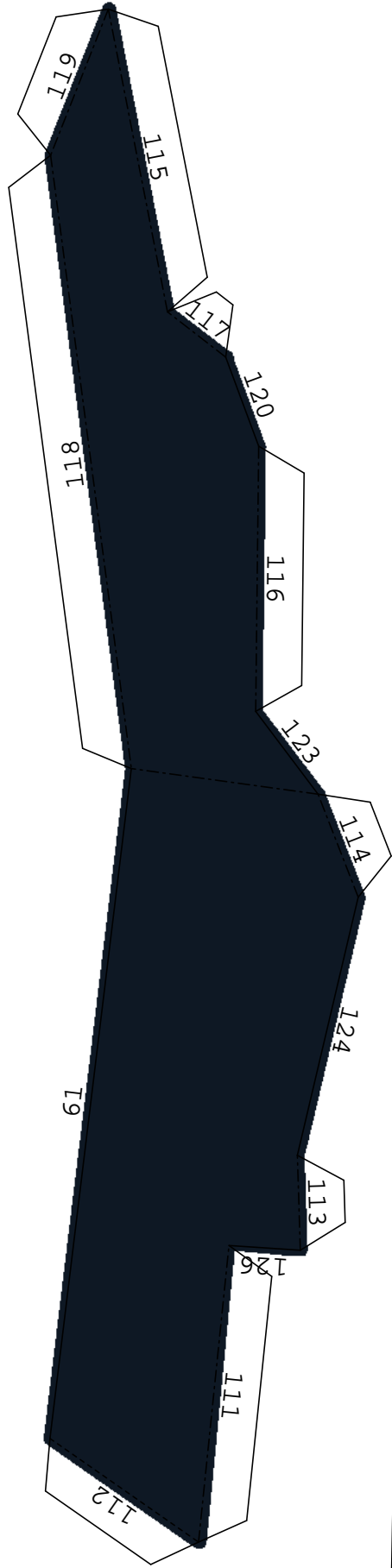
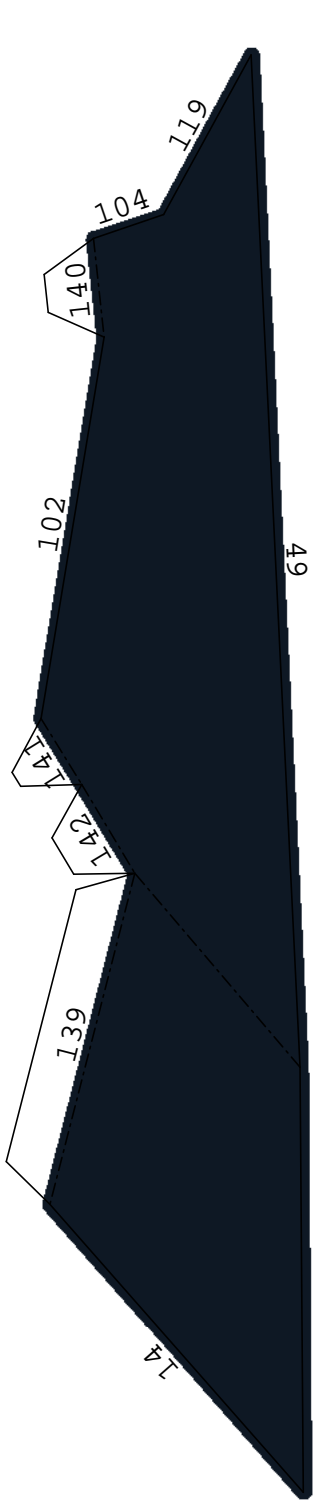

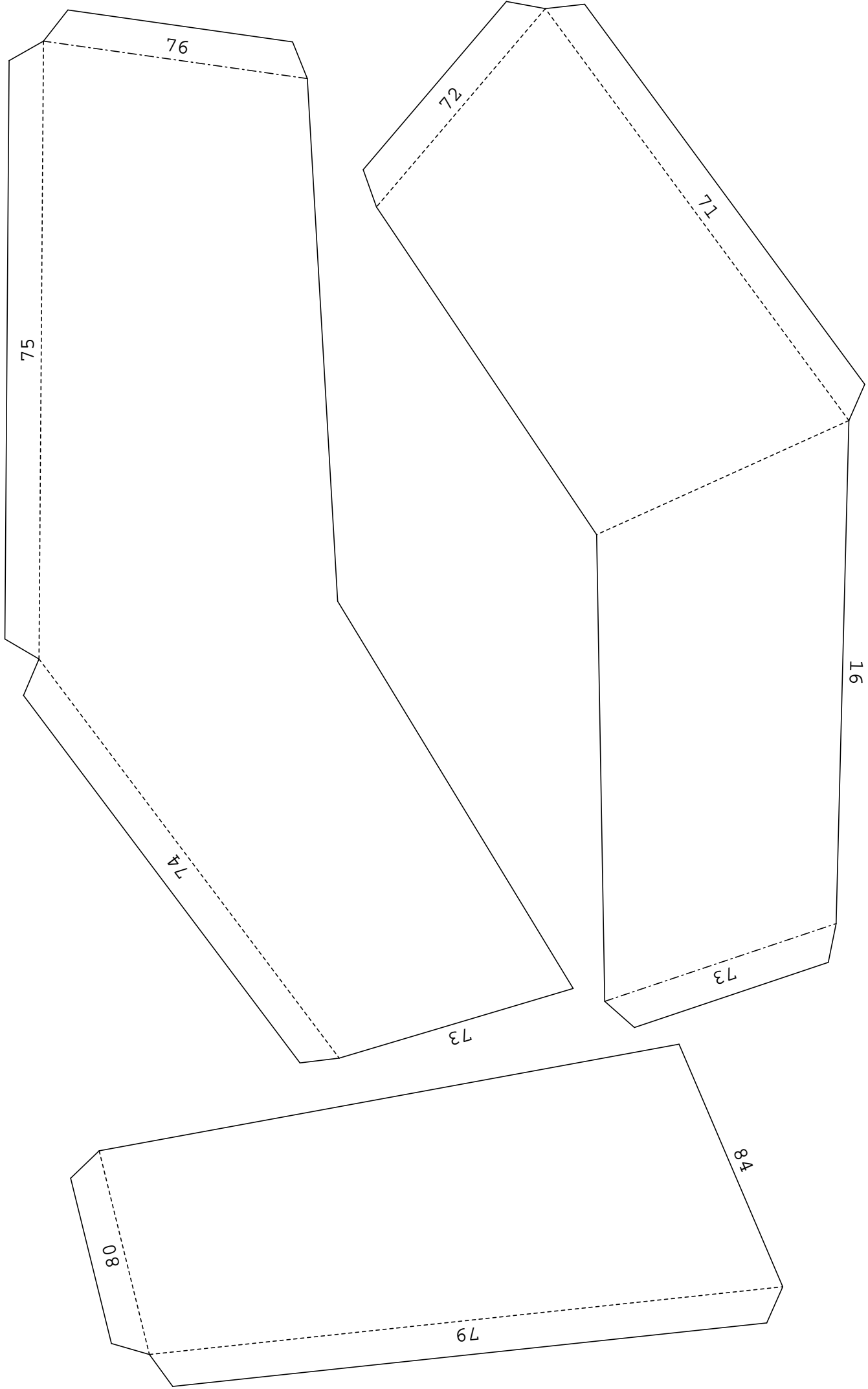

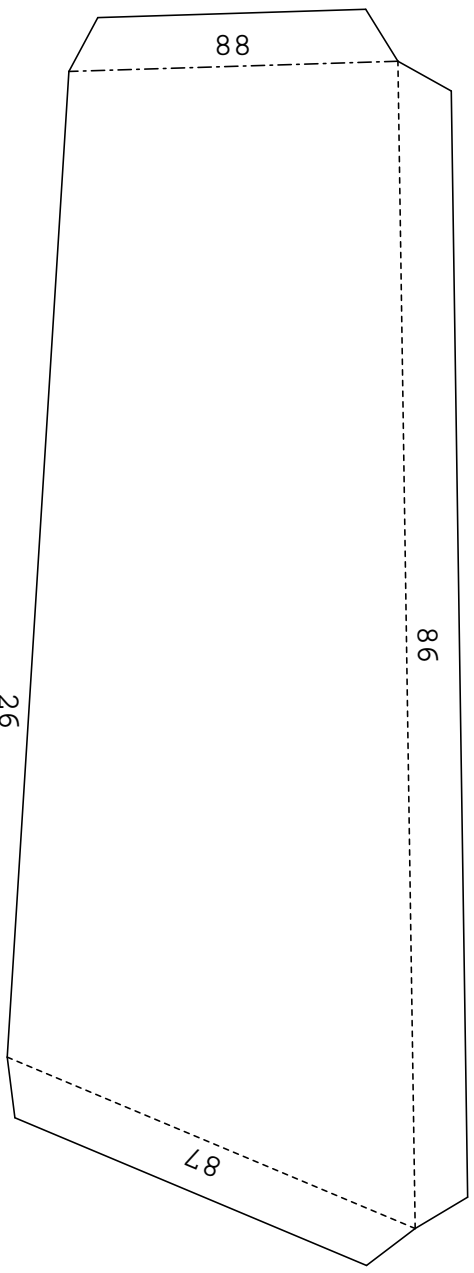
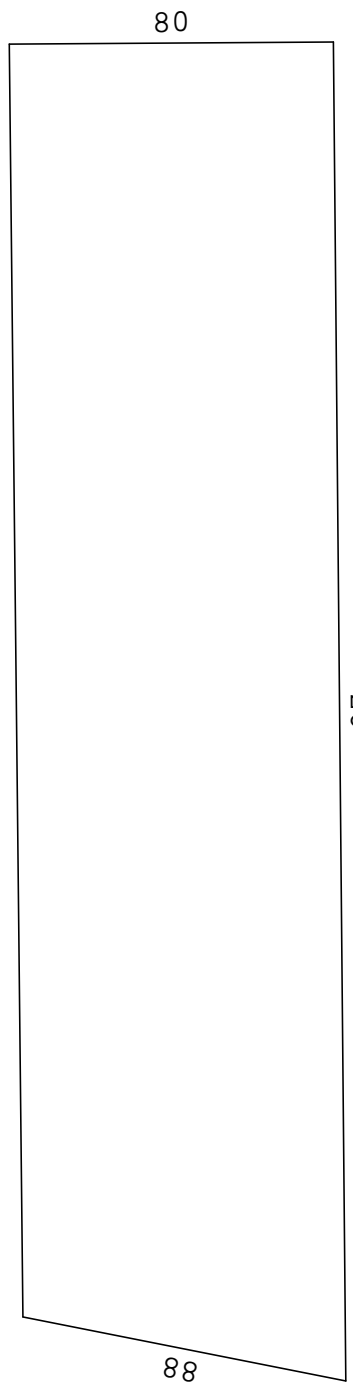
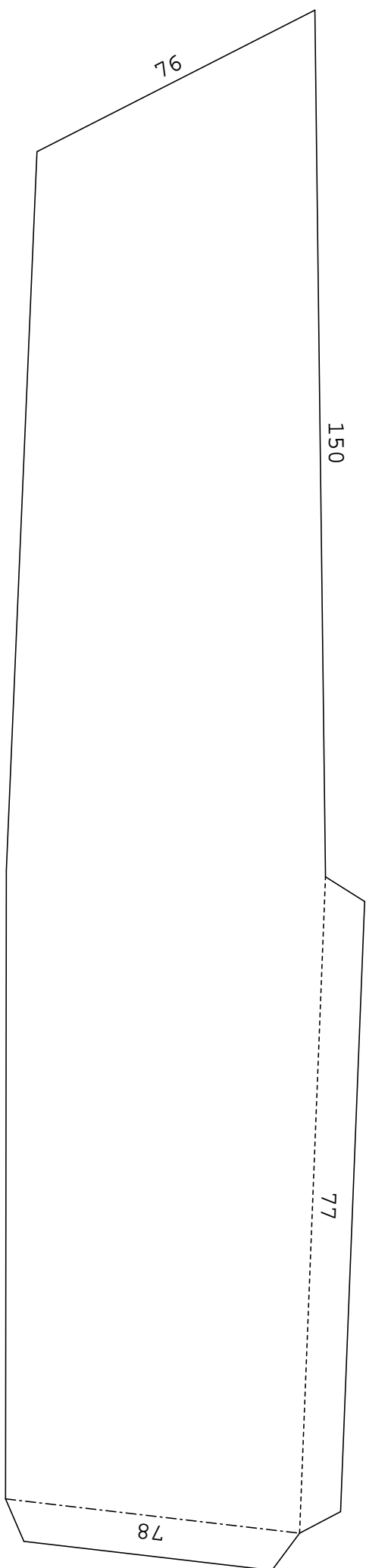

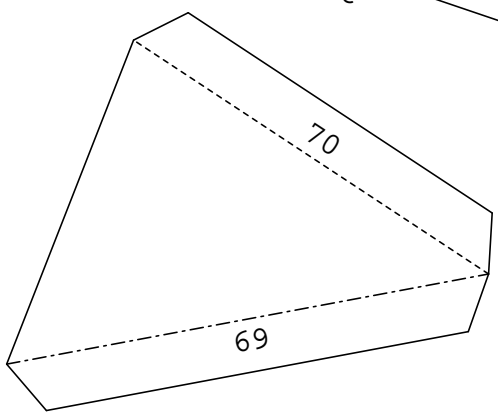
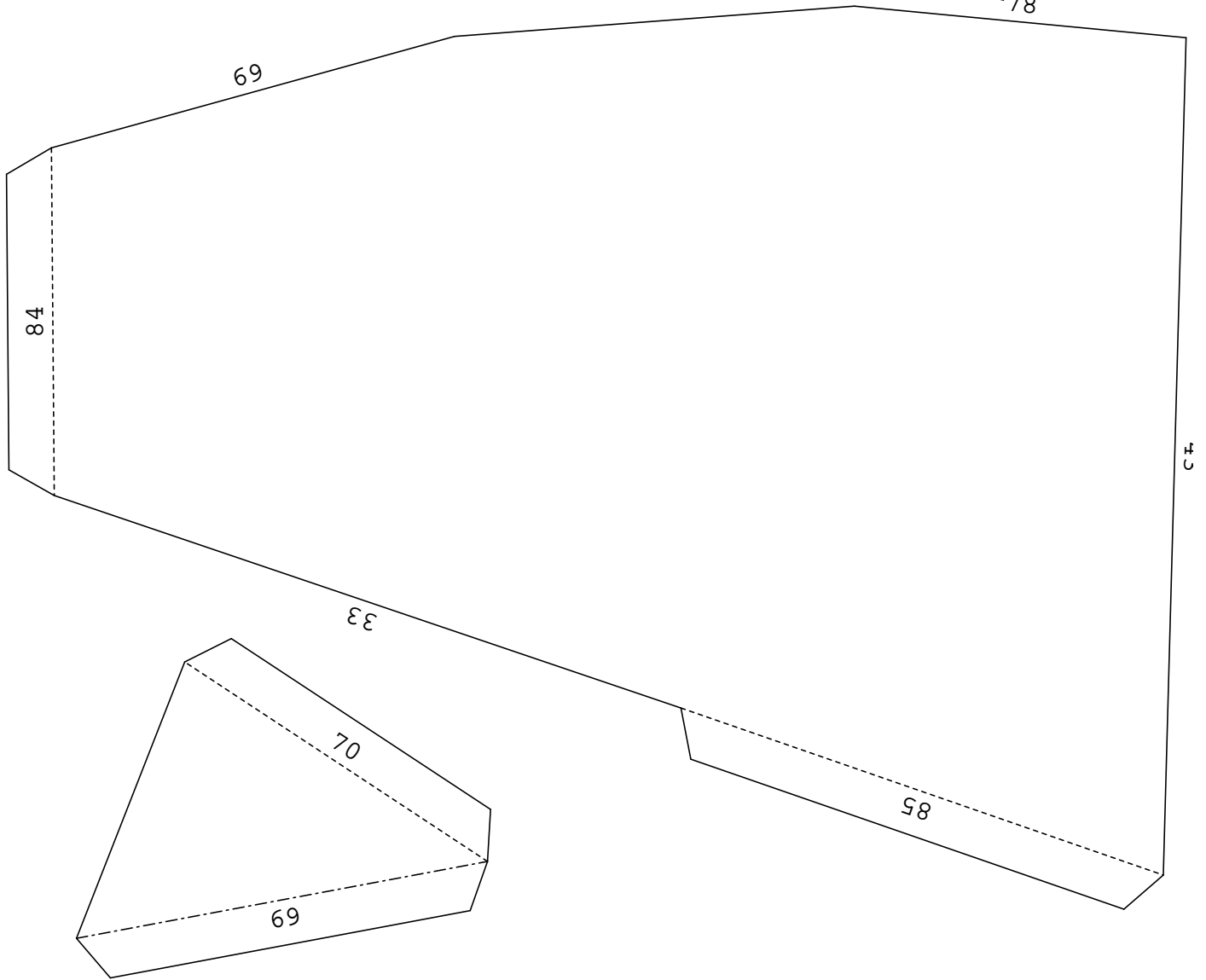
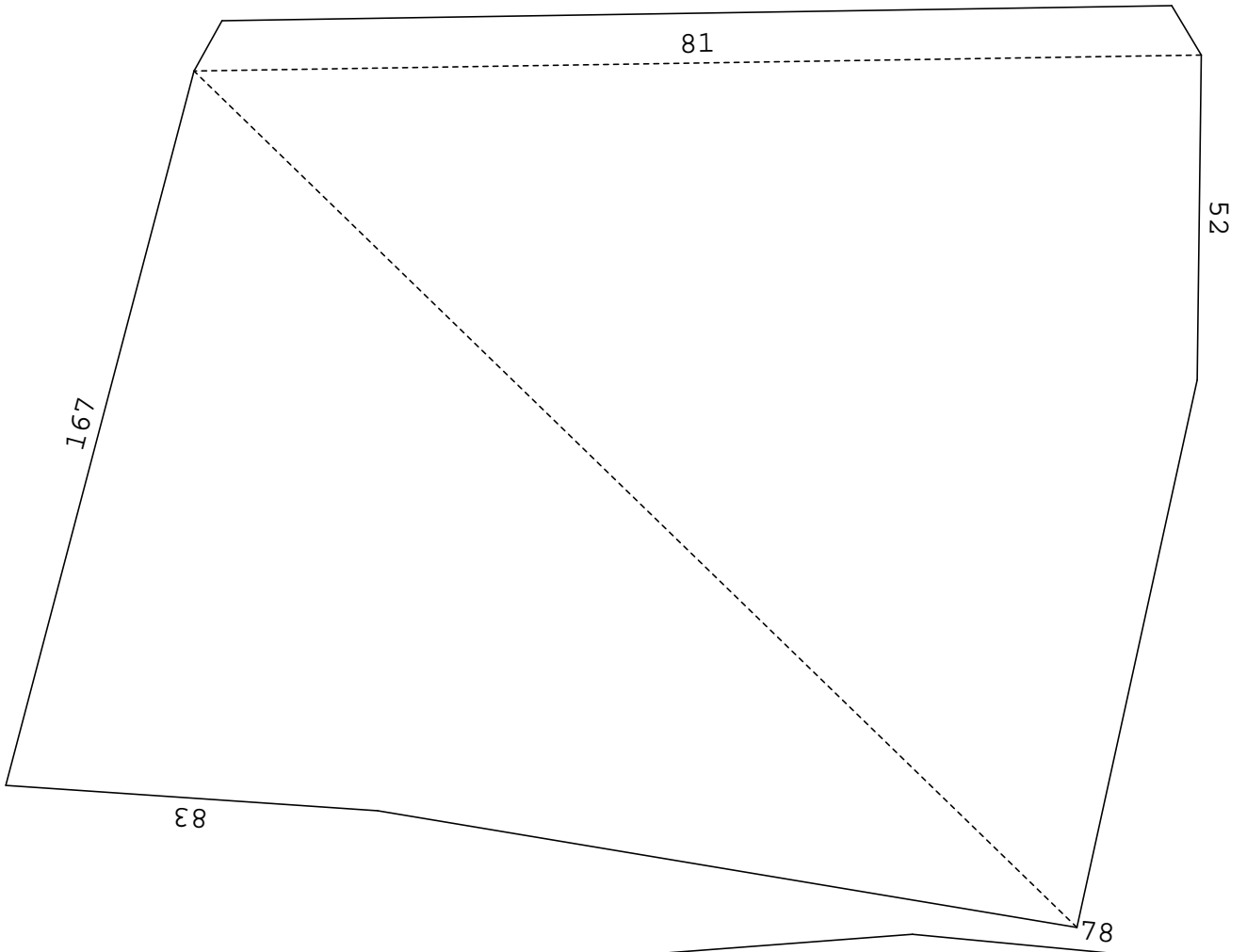



12

